

de

Technische
Legende

en

Technical
legend

fr

Légende
technique

it

Legenda
tecnica

es

Leyenda
técnica

pt

Legenda
técnica

fi

Tekninen
erittely

pl

Opis
techniczny

cs

Technická
legenda

ru

Технические
условные
обозначения



Schaltung, Layout, Schéma, Circuito, Circuito,
Circuito, Kytkaentä, Przelączanie, Zapojení, Схема

Endpole, Terminal posts, Bornes, Polo terminale,
Terminales, Pólos finais, Navat, Bieguny krańcowe,
Koncové póly, Конечные полюса

Bodenbefestigung, Bottom rail, Fixations par la batterie,
Fissaggio alla base, Fijación en el suelo, Fixação ao piso,
Pohjakiinnitys, Mocowanie do podłoża, Upevnění k pod-
laze, Напольное крепление

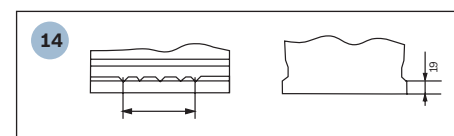
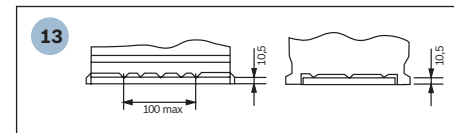
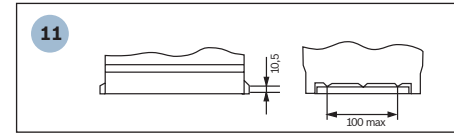
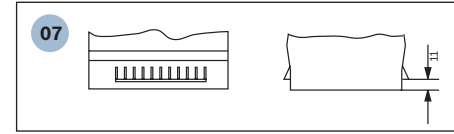
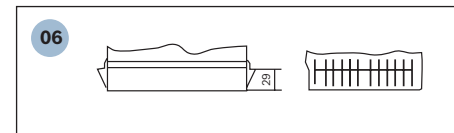
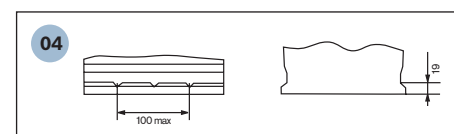
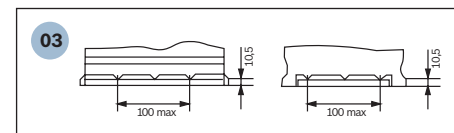
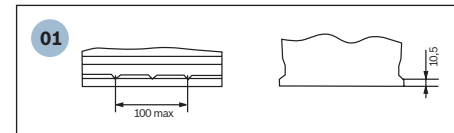
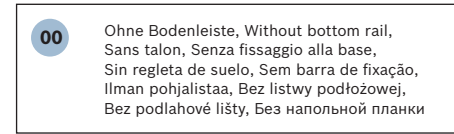
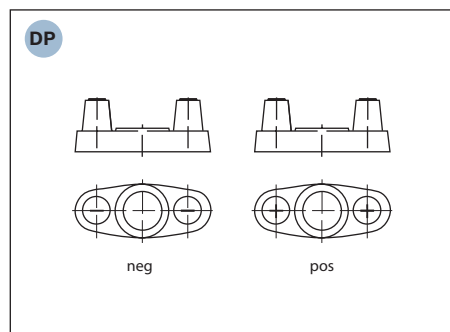
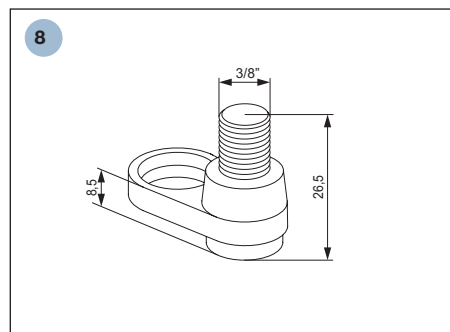
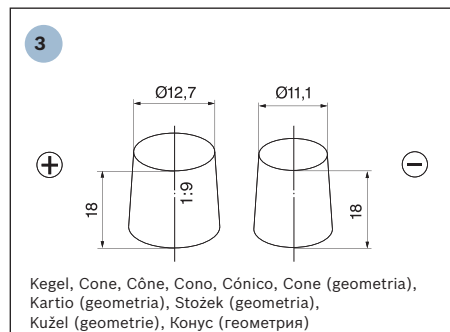
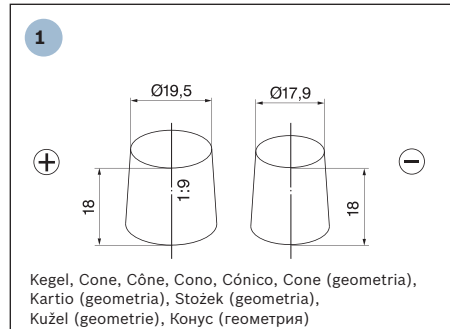
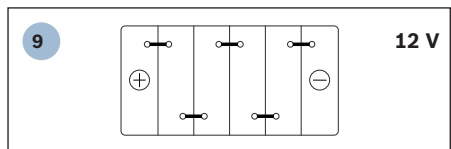
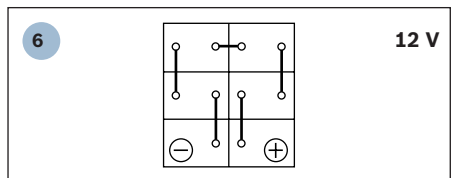
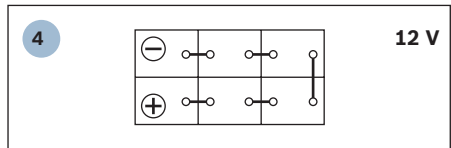
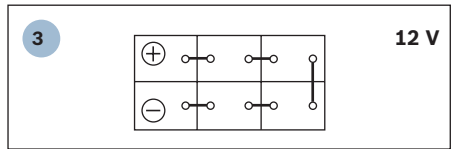
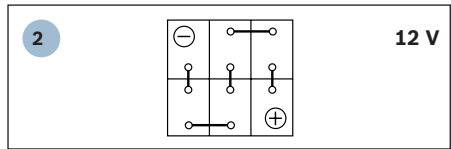
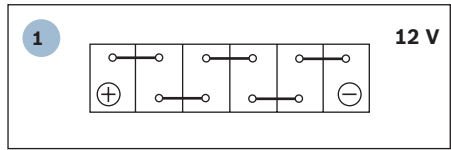
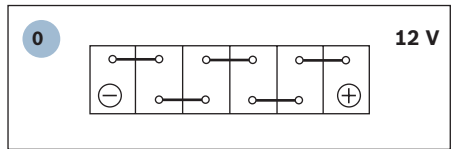
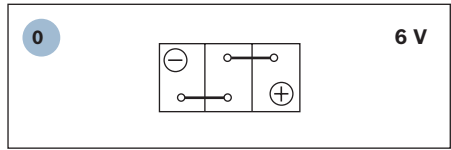

pt

Vista geral do
programa veículos
de passeio

fi

Tuotevalikoimat –
henkilöautot

pl

Przegląd asorty-
mentu – samochody
osobowe

cs

Přehled výrobního
programu pro osobní

ru

Обзор программ
для легковых



**S3 / 12 V**

| | | | | | | | | | | | | | | |
|-------------|----------------------|--------|--|--|--|----|-----|-----------------|---|---|-----|------------------|-------|----|
| 540 406 034 | 0 092 S30 000 | S3 000 | | | | 40 | 340 | 175 x 175 x 190 | 0 | 1 | B13 | 4047 024 659 407 | 9,87 | 72 |
| 541 400 036 | 0 092 S30 010 | S3 001 | | | | 41 | 360 | 207 x 175 x 175 | 0 | 1 | B13 | 4047 023 479 204 | 10,68 | 72 |
| 545 412 040 | 0 092 S30 020 | S3 002 | | | | 45 | 400 | 207 x 175 x 190 | 0 | 1 | B13 | 4047 023 479 228 | 11,43 | 72 |
| 545 413 040 | 0 092 S30 030 | S3 003 | | | | 45 | 400 | 207 x 175 x 190 | 1 | 1 | B13 | 4047 023 479 242 | 11,43 | 72 |
| 553 401 050 | 0 092 S30 041 | S3 004 | | | | 53 | 500 | 242 x 175 x 175 | 0 | 1 | B13 | 4047 024 937 574 | 13,62 | 63 |
| 556 400 048 | 0 092 S30 050 | S3 005 | | | | 56 | 480 | 242 x 175 x 190 | 0 | 1 | B13 | 4047 023 479 266 | 13,70 | 63 |
| 556 401 048 | 0 092 S30 060 | S3 006 | | | | 56 | 480 | 242 x 175 x 190 | 1 | 1 | B13 | 4047 023 479 280 | 13,70 | 63 |
| 570 144 064 | 0 092 S30 070 | S3 007 | | | | 70 | 640 | 278 x 175 x 175 | 0 | 1 | B13 | 4047 023 479 525 | 16,00 | 48 |
| 570 409 064 | 0 092 S30 080 | S3 008 | | | | 70 | 640 | 278 x 175 x 190 | 0 | 1 | B13 | 4047 023 479 570 | 16,60 | 48 |
| 588 403 074 | 0 092 S30 120 | S3 012 | | | | 88 | 740 | 353 x 175 x 175 | 0 | 1 | B13 | 4047 023 479 457 | 20,25 | 36 |
| 590 122 072 | 0 092 S30 130 | S3 013 | | | | 90 | 720 | 353 x 175 x 190 | 0 | 1 | B13 | 4047 023 479 464 | 20,78 | 36 |
| 545 077 030 | 0 092 S30 160 | S3 016 | | | | 45 | 300 | 220 x 135 x 225 | 0 | 1 | B01 | 4047 023 573 278 | 11,32 | 78 |
| 545 079 030 | 0 092 S30 170 | S3 017 | | | | 45 | 300 | 220 x 135 x 225 | 1 | 1 | B01 | 4047 023 573 261 | 11,32 | 78 |



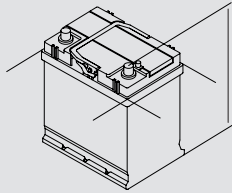

S3 / 6 V

| | | | | | | | | | | | | | | |
|-------------|----------------------|--------|--|--|--|----|-----|-----------------|---|---|-----|------------------|-------|----|
| 066 017 036 | 0 092 S30 600 | S3 060 | | | | 66 | 360 | 178 x 175 x 188 | 0 | 1 | B04 | 4047 024 437 708 | 11,90 | 96 |
| 077 015 036 | 0 092 S30 610 | S3 061 | | | | 77 | 360 | 216 x 170 x 191 | 0 | 1 | B06 | 4047 024 437 692 | 11,90 | 96 |

| | | | | |
|---|---|---|--|--|
| pt Bateria Bosch S5-S4-S3 para veículos de passeio 12 V (continuação) | fi Bosch-akut S5-S4-S3, 12 V: henkilöautot (jatkoa) | pl Akumulator Bosch S5-S4-S3 do samochodów osobowych 12 V (ciąg dalszy) | cs Akumulátory Bosch S5-S4-S3 pro osobní vozy 12 V (pokračování) | ru Аккумуляторы Bosch S5-S4-S3 для легковых автомобилей 12 В (продолжение) |
|---|---|---|--|--|

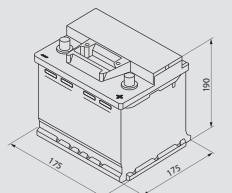
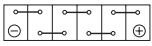
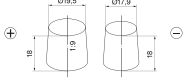
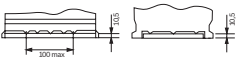
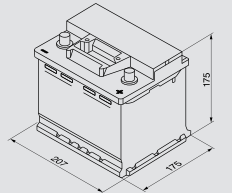
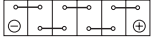
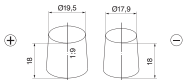
| ETN Bosch Reference Short code | Ah | A (EN) |  | L | T | B | EAN |  kg |  max. pcs. |
|--------------------------------------|----|--------|---|---|---|---|-----|--|---|
| | | |  | | | | | | |

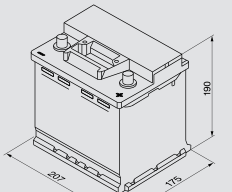
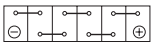
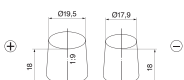
S3 (12 V)

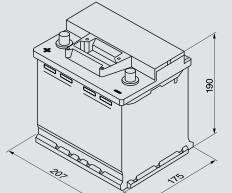
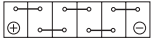
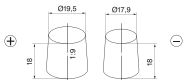
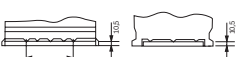
| | | | | | | | |
|---|----|-----|--|--|-------------------|-------|----|
| 540 406 034 0 092 S30 000 S3 000 | 40 | 340 |  175 x 175 x 190 |    | 4 047 024 659 407 | 9,87 | 72 |
| 541 400 036 0 092 S30 010 S3 001 | 41 | 360 |  207 x 175 x 175 |    | 4 047 023 479 204 | 10,68 | 72 |
| 545 412 040 0 092 S30 020 S3 002 | 45 | 400 |  207 x 175 x 190 |    | 4 047 023 479 228 | 11,43 | 72 |
| 545 413 040 0 092 S30 030 S3 003 | 45 | 400 |  207 x 175 x 190 |    | 4 047 023 479 242 | 11,43 | 72 |

A46



| | | | | |
|---|---|---|---|---|
| de Bosch-Batterie S5-S4-S3 für Pkw 12 V (Fortsetzung) | en Bosch battery S5-S4-S3 for cars 12 V (continued) | fr Batterie Bosch S5-S4-S3 pour véhicules particuliers 12 V (suite) | it Batteria Bosch S5-S4-S3 per autovetture 12 V (seguito) | es Batería Bosch S5-S4-S3 para turismos 12 V (continuación) |
|---|---|---|---|---|

| | | | | | | | |
|--|-------------------|---------------|---|----------------------------|------------|---|---|
|  ETN Bosch Reference Short code | Ah 20 h | A (EN) |  | L T B | EAN |  |  |
|--|-------------------|---------------|---|----------------------------|------------|---|---|

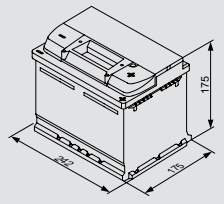
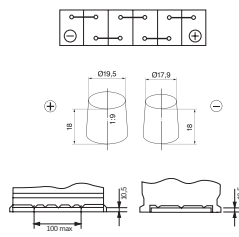
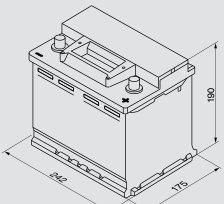
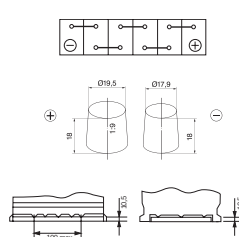
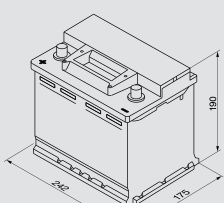
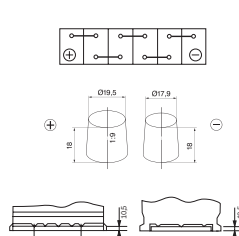
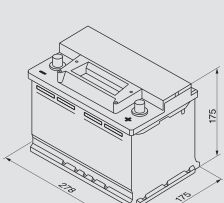
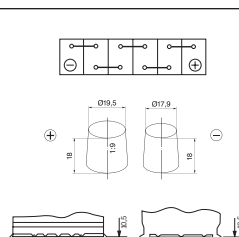
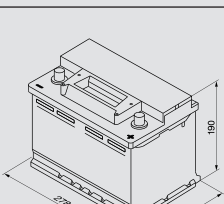
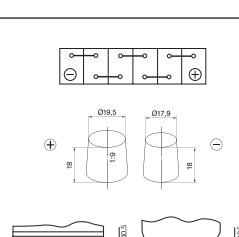
S3 (12 V)

| | | | | | | | |
|--|----|-----|--|--|-------------------|-------|----|
|  553 401 050 0 092 S30 041 S3 004 | 53 | 500 |  242 x 175 x 175 |  | 4 047 024 937 574 | 13,62 | 63 |
| 556 400 048 0 092 S30 050 S3 005 | 56 | 480 |  242 x 175 x 190 |  | 4 047 023 479 266 | 13,70 | 63 |
| 556 401 048 0 092 S30 060 S3 006 | 56 | 480 |  242 x 175 x 190 |  | 4 047 023 479 280 | 13,70 | 63 |
| 570 144 064 0 092 S30 070 S3 007 | 70 | 640 |  278 x 175 x 175 |  | 4 047 023 479 525 | 16,00 | 48 |
| 570 409 064 0 092 S30 080 S3 008 | 70 | 640 |  278 x 175 x 190 |  | 4 047 023 479 570 | 16,60 | 48 |

| | | | | |
|---|---|---|--|--|
| pt Bateria Bosch S5-S4-S3 para veículos de passeio 12 V (continuação) | fi Bosch-akut S5-S4-S3, 12 V: henkilöautot (jatkoa) | pl Akumulator Bosch S5-S4-S3 do samochodów osobowych 12 V (ciąg dalszy) | cs Akumulátory Bosch S5-S4-S3 pro osobní vozy 12 V (pokračování) | ru Аккумуляторы Bosch S5-S4-S3 для легковых автомобилей 12 В (продолжение) |
|---|---|---|--|--|

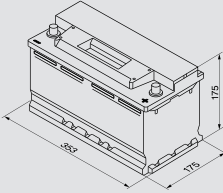
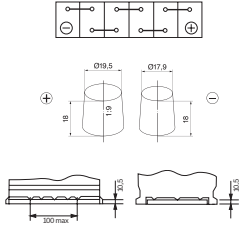
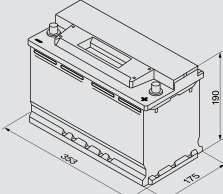
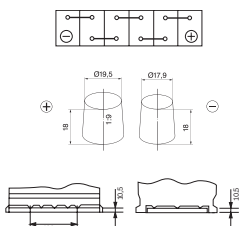
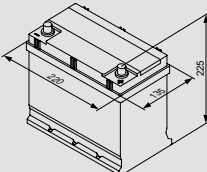
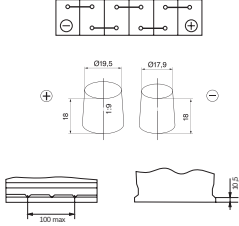
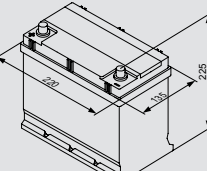
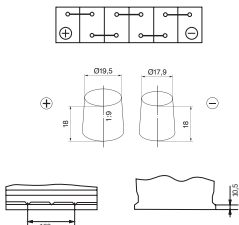
| ETN Bosch Reference Short code | Ah 20 h | A (EN) |  | L T B | EAN |  kg |  max. pcs. |
|---|------------|--------|---|--|-------------------|--|---|
| S3 (12 V) | | | | | | | |
| 588 403 074 0 092 S30 120 S3 012 | 88 | 740 |  |  | 4 047 023 479 457 | 20,25 | 36 |
| 590 122 072 0 092 S30 130 S3 013 | 90 | 720 |  |  | 4 047 023 479 464 | 20,78 | 36 |
| 545 077 030 0 092 S30 160 S3 016 | 45 | 300 |  |  | 4 047 023 573 278 | 11,32 | 78 |
| 545 079 030 0 092 S30 170 S3 017 | 45 | 300 |  |  | 4 047 023 573 261 | 11,32 | 78 |

de
Gegenüberstellung
Bosch-Batterien

en
Cross-reference
Bosch batteries

fr
Table de
correspondance
Batteries Bosch

it
Comparazione
Batterie Bosch

es
Equivalencias
Baterías Bosch



| Bosch High Tec → | | | Bosch S5 A – S5 – S4 – S3 | | |
|------------------|-------------|--------|---------------------------|-------------|--------|
| 0 092 S60 010 | 570 901 076 | S6 001 | 0 092 S5A 080 | 570 901 076 | S5 A08 |
| 0 092 S60 020 | 595 901 085 | S6 002 | 0 092 S5A 130 | 595 901 085 | S5 A13 |
| 0 097 H57 0P1 | 570 901 076 | 70H | 0 092 S5A 080 | 570 901 076 | S5 A08 |
| 0 097 H59 5P1 | 595 901 085 | 95H | 0 092 S5A 130 | 595 901 085 | S5 A13 |

| Bosch Silver Plus → | | | Bosch S5 A – S5 – S4 – S3 | | |
|---------------------|-------------|-----|---------------------------|-------------|--------|
| 0 093 T54 32Z | 543 107 048 | 4PT | 0 092 S40 010 | 544 402 044 | S4 001 |
| 0 093 T54 42X | 544 105 045 | 4CT | 0 092 S40 020 | 552 400 047 | S4 002 |
| 0 093 T54 42Y | 544 106 045 | 4DT | 0 092 S30 030 | 545 413 040 | S3 003 |
| 0 093 T54 52T | 545 101 048 | 4ET | 0 092 S40 010** | 544 402 044 | S4 001 |
| 0 093 T55 52Z | 555 107 054 | 5DT | 0 092 S40 050 | 560 408 054 | S4 005 |
| 0 093 T56 22V | 562 103 060 | 6CT | 0 092 S50 050 | 563 400 061 | S5 005 |
| 0 093 T56 32U | 563 102 060 | 6DT | 0 092 S30 070** | 570 144 064 | S3 007 |
| 0 093 T56 62T | 566 101 064 | 6FT | 0 092 S30 080 | 570 409 064 | S3 008 |
| 0 093 T58 82Z | 588 107 085 | 8AT | 0 092 S40 130 | 595 402 080 | S4 013 |

| Bosch Silver → | | | Bosch S5 A – S5 – S4 – S3 | | |
|----------------|-------------|-----|---------------------------|-------------|--------|
| 0 093 S53 6RV | 536 054 030 | 3F | 0 092 S30 010 | 541 400 036 | S3 001 |
| 0 093 S54 030 | 540 108 033 | 4F | 0 092 S40 000 | 542 400 039 | S4 000 |
| 0 093 S54 03K | 540 128 036 | 4FN | 0 092 S40 000 | 542 400 039 | S4 000 |
| 0 093 S54 05K | 540 200 036 | 4HN | 0 092 S30 010 | 541 400 036 | S3 001 |
| 0 093 S54 30J | 543 019 039 | 4B | 0 092 S40 010* | 544 402 044 | S4 001 |
| 0 093 S54 30N | 543 023 039 | 4P | 0 092 S40 010 | 544 402 044 | S4 001 |
| 0 093 S54 41N | 544 059 036 | 4C | 0 092 S30 020 | 545 412 040 | S3 002 |
| 0 093 S54 41N | 544 059 036 | 4CN | 0 092 S30 020 | 545 412 040 | S3 002 |
| 0 093 S54 41S | 544 064 036 | 4D | 0 092 S30 030 | 545 413 040 | S3 003 |
| 0 093 S54 41S | 544 064 036 | 4DN | 0 092 S30 030 | 545 413 040 | S3 003 |
| 0 093 S54 41X | 544 069 036 | 4S | 0 092 S40 010** | 544 402 044 | S4 001 |
| 0 093 S54 50J | 545 019 036 | 4E | 0 092 S40 010** | 544 402 044 | S4 001 |
| 0 093 S54 525 | 545 077 030 | 4K | 0 092 S30 160 | 545 077 030 | S3 016 |
| 0 093 S54 525 | 545 077 030 | 4KN | 0 092 S30 160 | 545 077 030 | S3 016 |
| 0 093 S54 527 | 545 079 030 | 4L | 0 092 S30 170 | 545 079 030 | S3 017 |
| 0 093 S54 527 | 545 079 030 | 4LN | 0 092 S30 170 | 545 079 030 | S3 017 |
| 0 093 S54 54R | 545 171 042 | 4PN | 0 092 S40 010 | 544 402 044 | S4 001 |
| 0 093 S54 54S | 545 172 042 | 4BN | 0 092 S40 010* | 544 402 044 | S4 001 |
| 0 093 S54 54T | 545 173 042 | 4EN | 0 092 S40 010** | 544 402 044 | S4 001 |
| 0 093 S55 01K | 550 056 054 | 5B | 0 092 S30 040 | 553 400 047 | S3 004 |
| 0 093 S55 01L | 550 057 054 | 5C | 0 092 S30 040* | 553 400 047 | S3 004 |
| 0 093 S55 01Y | 550 070 033 | 5H | 0 092 S40 020 | 552 400 047 | S4 002 |
| 0 093 S55 040 | 550 144 039 | 5K | 0 092 S40 020 | 552 400 047 | S4 002 |
| 0 093 S55 04A | 550 154 042 | 5KN | 0 092 S40 020 | 552 400 047 | S4 002 |
| 0 093 S55 04B | 550 155 054 | 5LN | 0 092 S50 010 | 552 401 052 | S5 001 |
| 0 093 S55 51N | 555 059 042 | 5D | 0 092 S30 050 | 556 400 048 | S3 005 |
| 0 093 S55 51N | 555 059 042 | 5DN | 0 092 S30 050 | 556 400 048 | S3 005 |
| 0 093 S55 51T | 555 065 042 | 5E | 0 092 S30 060 | 556 401 048 | S3 006 |
| 0 093 S55 51T | 555 065 042 | 5EN | 0 092 S30 060 | 556 401 048 | S3 006 |
| 0 093 S55 54B | 555 155 054 | 5BN | 0 092 S40 040 | 560 409 054 | S4 004 |
| 0 093 S55 54C | 555 156 054 | 5CN | 0 092 S40 040* | 560 409 054 | S4 004 |
| 0 093 S56 025 | 560 077 060 | 6H | 0 092 S50 040 | 561 400 060 | S5 004 |

pt

Comparação
das baterias Bosch

fi

Bosch-akkujen
vertailu

pl

Porównanie
akumulatorów Bosch

cs

Porovnání
akumulátorů Bosch

ru

Сравнение
аккумуляторов
Bosch



ETN



ETN



| | | | | | |
|---------------|-------------|-----|-----------------|-------------|--------|
| 0 093 S56 02R | 560 099 028 | 6B | 0 092 S40 270 | 570 413 063 | S4 027 |
| 0 093 S56 0S0 | 560 098 028 | 6A | 0 092 S40 260 | 570 412 063 | S4 026 |
| 0 093 S56 0S6 | 560 170 064 | 6HN | 0 092 S50 040 | 561 400 060 | S5 004 |
| 0 093 S56 20J | 562 019 048 | 6C | 0 092 S40 050 | 560 408 054 | S4 005 |
| 0 093 S56 20J | 562 019 048 | 6CN | 0 092 S40 050 | 560 408 054 | S4 005 |
| 0 093 S56 20L | 562 021 048 | 6M | 0 092 S50 060 | 563 401 061 | S5 006 |
| 0 093 S56 22V | 562 103 060 | 6PN | 0 092 S50 050 | 563 400 061 | S5 005 |
| 0 093 S56 22W | 562 104 060 | 6MN | 0 092 S50 060 | 563 401 061 | S5 006 |
| 0 093 S56 2B4 | 562 400 048 | 6NN | 0 092 S40 060 | 560 127 054 | S4 006 |
| 0 093 S56 3RS | 563 018 051 | 6D | 0 092 S30 070** | 570 144 064 | S3 007 |
| 0 093 S56 40K | 564 020 064 | 6E | 0 092 S30 070** | 570 144 064 | S3 007 |
| 0 093 S56 615 | 566 041 051 | 6F | 0 092 S30 080 | 570 409 064 | S3 008 |
| 0 093 S57 020 | 570 072 051 | 7A | 0 092 S40 270 | 570 413 063 | S4 027 |
| 0 093 S57 021 | 570 073 051 | 7BA | 0 092 S40 260 | 570 412 063 | S4 026 |
| 0 093 S57 040 | 570 144 064 | 7EN | 0 092 S40 070 | 572 409 068 | S4 007 |
| 0 093 S57 041 | 570 145 064 | 7DN | 0 092 S40 070* | 572 409 068 | S4 007 |
| 0 093 S57 042 | 570 146 064 | 7GN | 0 092 S40 070** | 572 409 068 | S4 007 |
| 0 093 S57 10D | 571 013 068 | 7E | 0 092 S40 070 | 572 409 068 | S4 007 |
| 0 093 S57 10E | 571 014 068 | 7D | 0 092 S40 070* | 572 409 068 | S4 007 |
| 0 093 S57 20U | 572 030 064 | 7G | 0 092 S40 070** | 572 409 068 | S4 007 |
| 0 093 S57 40C | 574 012 068 | 7C | 0 092 S40 080 | 574 012 068 | S4 008 |
| 0 093 S57 40C | 574 012 068 | 7CN | 0 092 S40 080 | 574 012 068 | S4 008 |
| 0 093 S57 40D | 574 013 068 | 7F | 0 092 S40 090 | 574 013 068 | S4 009 |
| 0 093 S57 40D | 574 013 068 | 7FN | 0 092 S40 090 | 574 013 068 | S4 009 |
| 0 093 S57 53D | 575 121 072 | 7HN | 0 092 S50 070 | 574 402 075 | S5 007 |
| 0 093 S58 017 | 580 043 064 | 8C | 0 092 S40 100 | 580 406 074 | S4 010 |
| 0 093 S58 03E | 580 122 072 | 8CN | 0 092 S40 100 | 580 406 074 | S4 010 |
| 0 093 S58 50F | 585 015 076 | 8B | 0 092 S30 120 | 588 403 074 | S3 012 |
| 0 093 S58 50F | 585 015 076 | 8BN | 0 092 S30 120 | 588 403 074 | S3 012 |
| 0 093 S58 55K | 585 200 080 | 8DN | 0 092 S50 100 | 585 200 080 | S5 010 |
| 0 093 S58 80X | 588 033 064 | 8A | 0 092 S30 130 | 590 122 072 | S3 013 |
| 0 093 S59 03E | 590 122 072 | 9BN | 0 092 S30 130 | 590 122 072 | S3 013 |
| 0 093 S59 03F | 590 123 072 | 9AN | 0 092 S30 130** | 590 122 072 | S3 013 |
| 0 093 S59 2RU | 592 026 076 | 9A | 0 092 S40 130** | 595 402 080 | S4 013 |
| 0 093 S59 55K | 595 200 085 | 9CN | 0 092 S50 130 | 600 402 083 | S5 013 |
| 0 093 S60 018 | 600 044 076 | 1A | 0 092 S50 130 | 600 402 083 | S5 013 |
| 0 093 S60 03N | 600 131 080 | 1AN | 0 092 S50 130 | 600 402 083 | S5 013 |
| 0 093 S61 05K | 610 200 085 | 1BN | 0 092 S50 150 | 610 402 092 | S5 015 |

Bosch Asia Silver →

Bosch S5 A – S5 – S4 – S3

| | | | | | |
|---------------|-------------|-----|---------------|-------------|--------|
| 0 093 A54 03J | 540 127 033 | 4CA | 0 092 S40 190 | 540 127 033 | S4 019 |
| 0 093 A54 0S1 | 540 126 033 | 4BA | 0 092 S40 180 | 540 126 033 | S4 018 |
| 0 093 A54 54B | 545 155 033 | 4DA | 0 092 S40 200 | 545 155 033 | S4 020 |
| 0 093 A54 54C | 545 156 033 | 4EA | 0 092 S40 210 | 545 156 033 | S4 021 |
| 0 093 A54 54D | 545 157 033 | 4FA | 0 092 S40 220 | 545 157 033 | S4 022 |

* Ford-Pol-Adapter erforderlich (s. S. 25) / Ford terminal adapter required (s. p. 25) / Adaptateur de pôle Ford nécessaire (v. p. 25) /
Necessari adattatori poli Ford (v. p. 25) / Se requiere adaptador terminal Ford (v. p. 25)

Necessário adaptador de pólos Ford (v. pág. 25) / Ford-napasovitin tarpeen (ks. sivu 25) / Niezbędny adapter biegun Ford (p. str. 25) /
Pólový adaptér Ford nutný (viz str. 25) / Небходим адаптер полюса Ford (см. стр. 25)

** Bodenleisten-Adapter erforderlich (s. S. 25) / Bottom rail adapter required (s. p. 25) / Adaptateur pour rebord de fixation
nécessaire (v. p. 25) / Necessario adattatore listello di fissaggio (v. p. 25) / Se requiere adaptador regleta de suelo (v. p. 25)

Necessário adaptador de barras de fixação (v. pág. 25) / Pohjalistan sovitin tarpeen (ks. sivu 25) / Niezbędny adapter listew podłożowych (p. str. 25) /
Adaptér pro upínací lišty nutný (viz str. 25) / Небходим адаптер напольной планки (см. стр. 25)

de

**Gegenüberstellung
Bosch-Batterien**
(Fortsetzung)

en

**Cross-reference
Bosch batteries**
(continued)

fr

**Table de
correspondance
Batteries Bosch**
(suite)

it

**Comparazione
Batterie Bosch**
(seguito)

es

**Equivalencias
Baterías Bosch**
(continuación)



ETN



Nº



ETN



Nº

Bosch Asia Silver →**Bosch S5 A – S5 – S4 – S3**

| | | | | | |
|---------------|-------------|-----|---------------|-------------|--------|
| 0 093 A54 54E | 545 158 033 | 4GA | 0 092 S40 230 | 545 158 033 | S4 023 |
| 0 093 A56 04G | 560 160 042 | 6AA | 0 092 S40 260 | 570 412 063 | S4 026 |
| 0 093 A56 04H | 560 161 042 | 6BA | 0 092 S40 270 | 570 413 063 | S4 027 |
| 0 093 A56 04J | 560 163 042 | 6EA | 0 092 S40 250 | 560 411 054 | S4 025 |
| 0 093 A56 0S4 | 560 162 042 | 6DA | 0 092 S40 240 | 560 410 054 | S4 024 |
| 0 093 A57 03T | 570 137 057 | 7BA | 0 092 S40 260 | 570 412 063 | S4 026 |
| 0 093 A57 03U | 570 138 057 | 7AA | 0 092 S40 270 | 570 413 063 | S4 027 |
| 0 093 A59 52W | 595 104 068 | 9BA | 0 092 S40 280 | 595 404 083 | S4 028 |
| 0 093 A59 52X | 595 105 068 | 9CA | 0 092 S40 290 | 595 405 083 | S4 029 |

Bosch Standard →**Bosch S5 A – S5 – S4 – S3**

| | | | | | |
|---------------|-------------|--|-----------------|-------------|--------|
| 0 180 606 60H | 066 017 036 | | 0 092 S30 600 | 066 017 036 | S3 060 |
| 0 180 607 70F | 077 015 036 | | 0 092 S30 610 | 077 015 036 | S3 061 |
| 0 180 654 525 | 545 077 030 | | 0 092 S30 160 | 545 077 030 | S3 016 |
| 0 180 654 527 | 545 079 030 | | 0 092 S30 170 | 545 079 030 | S3 017 |
| 0 180 655 015 | 550 041 036 | | 0 092 S40 240 | 560 410 054 | S4 024 |
| 0 180 655 016 | 550 042 036 | | 0 092 S40 250 | 560 411 054 | S4 025 |
| 0 180 656 025 | 560 077 060 | | 0 092 S50 040** | 561 400 060 | S5 004 |
| 0 180 657 513 | 575 039 064 | | 0 092 S40 100 | 580 406 074 | S4 010 |
| 0 180 658 017 | 580 043 064 | | 0 092 S40 100 | 580 406 074 | S4 010 |
| 0 180 660 018 | 600 044 076 | | 0 092 S50 130 | 600 402 083 | S5 013 |
| 0 180 653 50K | 535 020 024 | | 0 092 S40 180 | 540 126 033 | S4 018 |
| 0 180 653 50M | 535 022 024 | | 0 092 S40 190 | 540 127 033 | S4 019 |
| 0 180 653 6RV | 536 054 030 | | 0 092 S30 010 | 541 400 036 | S3 001 |
| 0 180 653 82U | 538 102 030 | | 0 092 S40 000 | 542 400 039 | S4 000 |
| 0 180 654 30H | 543 017 033 | | 0 092 S40 010* | 544 402 044 | S4 001 |
| 0 180 654 3RT | 543 024 033 | | 0 092 S40 010 | 544 402 044 | S4 001 |
| 0 180 654 41N | 544 059 036 | | 0 092 S30 020 | 545 412 040 | S3 002 |
| 0 180 654 41S | 544 064 036 | | 0 092 S30 030 | 545 413 040 | S3 003 |
| 0 180 654 41X | 544 069 036 | | 0 092 S40 010** | 544 402 044 | S4 001 |
| 0 180 654 50J | 545 019 036 | | 0 092 S40 010** | 544 402 044 | S4 001 |
| 0 180 654 50N | 545 023 030 | | 0 092 S40 210 | 545 156 033 | S4 021 |
| 0 180 654 50O | 545 024 030 | | 0 092 S40 230 | 545 158 033 | S4 023 |
| 0 180 654 51F | 545 051 030 | | 0 092 S40 220 | 545 157 033 | S4 022 |
| 0 180 654 52C | 545 084 030 | | 0 092 S40 200 | 545 155 033 | S4 020 |
| 0 180 655 01I | 550 054 039 | | 0 092 S40 020 | 552 400 047 | S4 002 |
| 0 180 655 01K | 550 056 054 | | 0 092 S30 040 | 553 400 047 | S3 004 |
| 0 180 655 01L | 550 057 054 | | 0 092 S30 040* | 553 400 047 | S3 004 |
| 0 180 655 01U | 550 066 033 | | 0 092 S40 020 | 552 400 047 | S4 002 |
| 0 180 655 51N | 555 059 042 | | 0 092 S30 050 | 556 400 048 | S3 005 |
| 0 180 655 51T | 555 065 042 | | 0 092 S30 060 | 556 401 048 | S3 006 |
| 0 180 656 01C | 560 048 028 | | 0 092 S40 260 | 570 412 063 | S4 026 |
| 0 180 656 01D | 560 049 028 | | 0 092 S40 270 | 570 413 063 | S4 027 |
| 0 180 656 01W | 560 068 039 | | 0 092 S40 240 | 560 410 054 | S4 024 |
| 0 180 656 01X | 560 069 039 | | 0 092 S40 250 | 560 411 054 | S4 025 |
| 0 180 656 20J | 562 019 048 | | 0 092 S40 050 | 560 408 054 | S4 005 |
| 0 180 656 3RS | 563 018 051 | | 0 092 S30 070** | 570 144 064 | S3 007 |
| 0 180 656 40K | 564 020 064 | | 0 092 S30 070** | 570 144 064 | S3 007 |
| 0 180 656 50U | 565 030 054 | | 0 092 S30 070 | 570 144 064 | S3 007 |

pt

Comparação das baterias Bosch
(continuação)

fi

Bosch-akkujen vertailu
(jatkoa)

pl

Porównanie akumulatorów Bosch
(ciąg dalszy)

cs

Porovnání akumulátorů Bosch
(pokračování)

ru

Сравнение аккумуляторов Bosch
(продолжение)



ETN



ETN



| | | | | | |
|---------------|-------------|--|-----------------|-------------|--------|
| 0 180 657 00T | 570 029 054 | | 0 092 S40 260 | 570 412 063 | S4 026 |
| 0 180 657 0RT | 570 024 054 | | 0 092 S40 270 | 570 413 063 | S4 027 |
| 0 180 657 10D | 571 013 068 | | 0 092 S40 070 | 572 409 068 | S4 007 |
| 0 180 657 10E | 571 014 068 | | 0 092 S40 070* | 572 409 068 | S4 007 |
| 0 180 657 20U | 572 030 064 | | 0 092 S40 070** | 572 409 068 | S4 007 |
| 0 180 657 40C | 574 012 068 | | 0 092 S40 080 | 574 012 068 | S4 008 |
| 0 180 657 40D | 574 013 068 | | 0 092 S40 090 | 574 013 068 | S4 009 |
| 0 180 658 50F | 585 015 076 | | 0 092 S30 120 | 588 403 074 | S3 012 |
| 0 180 658 50L | 585 021 054 | | 0 092 S40 280 | 595 404 083 | S4 028 |
| 0 180 658 50M | 585 022 054 | | 0 092 S40 290 | 595 405 083 | S4 029 |
| 0 180 659 20Q | 592 026 076 | | 0 092 S40 130** | 595 402 080 | S4 013 |
| 0 180 659 50I | 595 018 064 | | 0 092 S40 280 | 595 404 083 | S4 028 |
| 0 180 659 50J | 595 019 064 | | 0 092 S40 290 | 595 405 083 | S4 029 |

* Ford-Pol-Adapter erforderlich (s. S. 25) / Ford terminal adapter required (s. p.25) / Adaptateur de pôle Ford nécessaire (v. p. 25) / Necessari adattatori poli Ford (v. p. 25) / Se requiere adaptador terminal Ford (v. p. 25) / Necessário adaptador de pólos Ford (v. pág. 25) / Ford-napasovitin tarpeen (ks. sivu 25) / Niezbędny adapter biegun Ford (p. str. 25) / Pólóv adaptér Ford nutný (viz str. 25) / Необходим адаптер полюса Ford (см. стр. 25)

** Bodenleisten-Adapter erforderlich (s. S. 25) / Bottom rail adapter required (s. p. 25) / Adaptateur pour rebord de fixation nécessaire (v. p. 25) / Necessario adattatore listello di fissaggio (v. p. 25) / Se requiere adaptador regleta de suelo (v. p. 25) / Necessário adaptador de barras de fixação (v. pág. 25) / Pohjalistan sovitin tarpeen (ks. sivu 25) / Niezbędny adapter listew podłożowych (p. str. 25) / Адаптер про урінаці лішты nutný (viz str. 25) / Необходим адаптер напольной планки (см. стр. 25)