

SCHEMA DI MONTAGGIO Armadio Spogliatoio 330 1 posto

Dimensioni L x P x H mm. 360x350x1795

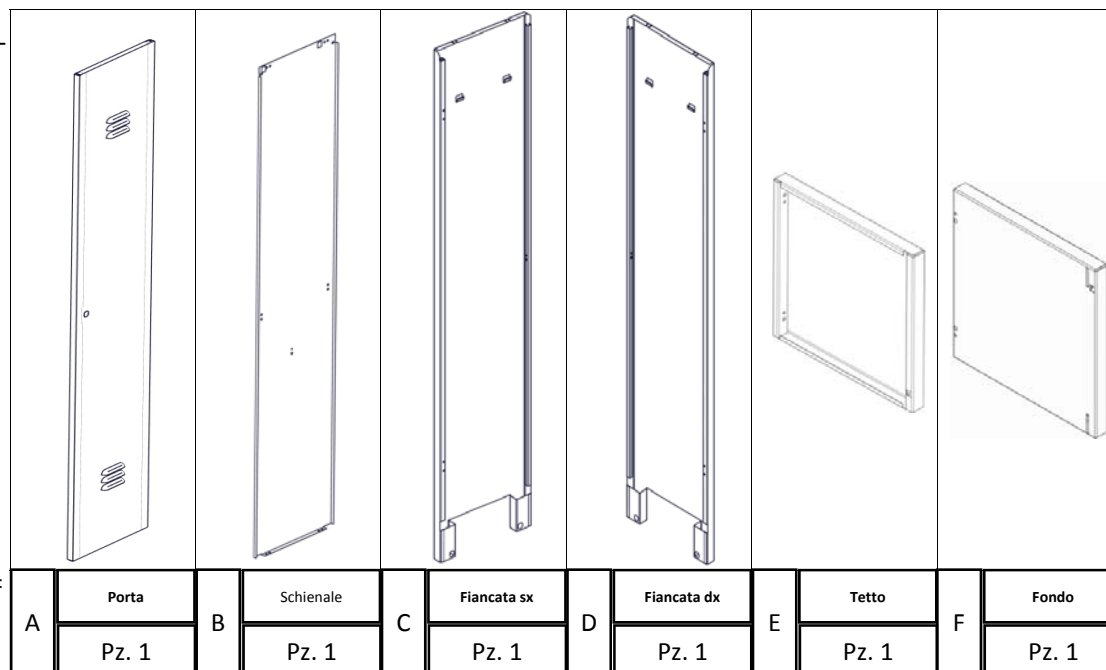

AVVERTENZE DURANTE IL MONTAGGIO:

a causa dei processi produttivi che possono aver generato piccole sbavature dei materiali, si consiglia l'utilizzo dei guanti durante le fasi di montaggio









MODALITA' DI SMALTIMENTO DELL'ARMADIO:

questo prodotto non rientra tra i rifiuti solidi urbani. Pertanto, rivolgersi ai servizi del proprio comune.

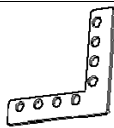
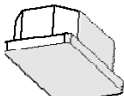

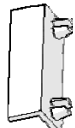
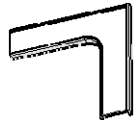
MODALITA' DI PULIZIA DELL'ARMADIO:

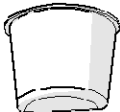
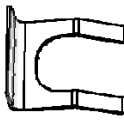
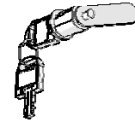
per la pulizia non utilizzare prodotti corrosivi, solventi e abrasivi.

										
G	H	I	L	M	N	O	P	Q	R	S
Vite M5	Squadretta	Piedino	Cerniera	Battuta porta	Salvamuro	Pianetto	Bicchierino	Linguetta	Serratura	Portasciugamano
Pz. 42	Pz. 8	Pz. 4	Pz. 2	Pz. 2	Pz. 4	Pz. 1	Pz. 1	Pz. 1	Pz. 1	Pz. 1

